

Modell 007-24
Klappsitz für Wandeinbau
 Edelstahl-Ausführung

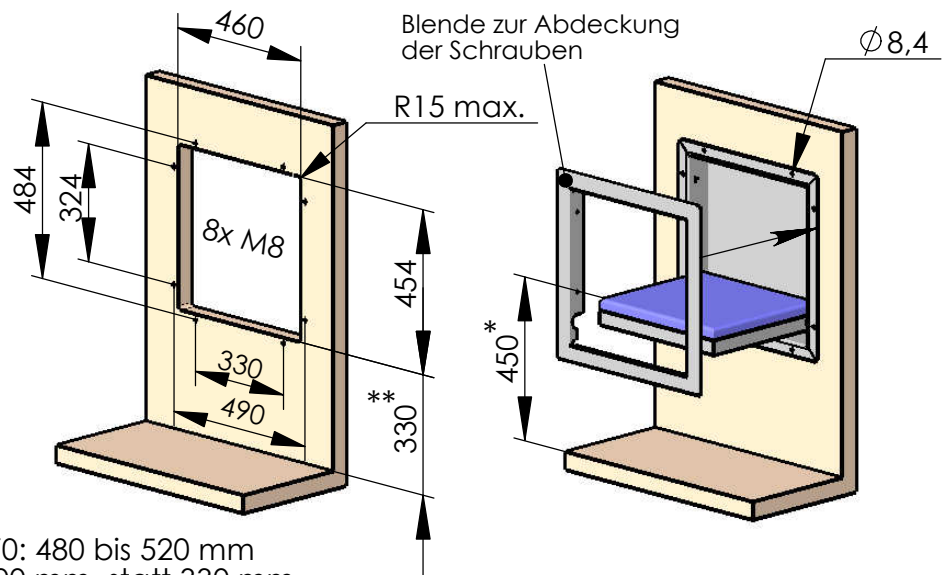
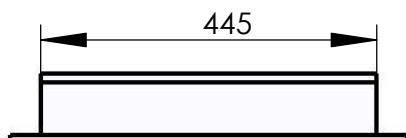
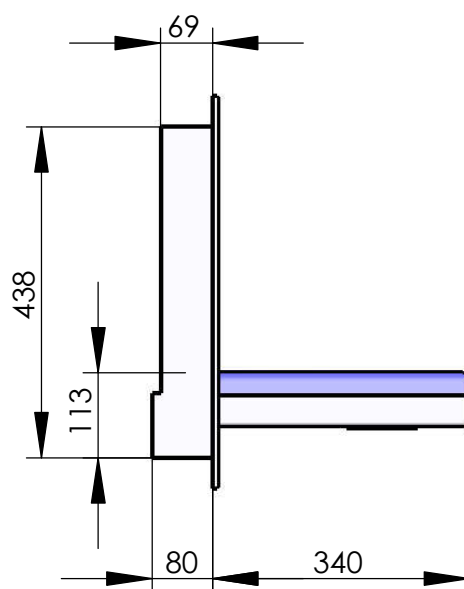
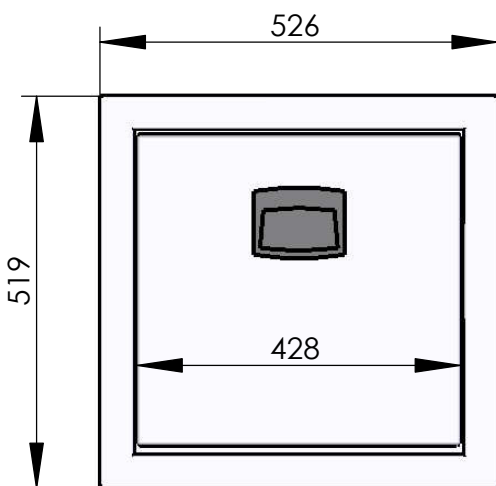
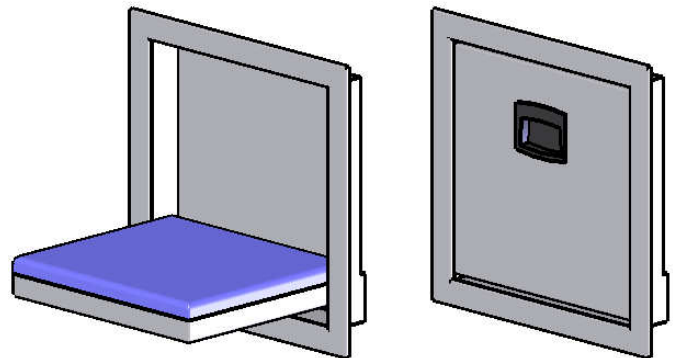

* Sitzhöhe gemäß DIN EN 81-70: 480 bis 520 mm
 ** dementsprechend 360 bis 400 mm, statt 330 mm